



Front Surround System
YAS-109
Owner's Manual

-
- **Read the supplied booklet “Safety Brochure” before using the unit.**

CONTENTS

INTRODUCTION 4

BEFORE USING THE UNIT 6

Features 6

Accessories 9

Using the remote control 9

Part names and functions 11

PREPARATION 15

1 Installation 15

Installing the unit 15

2 Connecting a TV 16

Connecting a TV that supports Audio Return Channel (ARC) 16

Connecting a TV that does not support Audio Return Channel (ARC) 17

3 Connecting AV devices 17

HDMI connection with an AV device 17

4 Connecting an external subwoofer 18

Connecting an external subwoofer 18

5 Connecting to power 18

Connecting to power 18

6 Connecting to a network 19

Network functions 19

Wired network connections 19

Wireless network connections 20

Connecting to a network with the Sound Bar Controller app 20

PLAYBACK 22

Basic operations 22

Basic procedure for playback 22

Operating the unit using voice commands (Amazon Alexa) 24

Enjoying your favorite sound 27

Playback with 3D surround sound/surround sound 27

Selecting a surround mode 27

Playback with 2-channel stereo sound 27

Playback of human voices clearly (Clear Voice) 28

Enjoying enhanced bass sound (Bass Extension) 28

Using a Bluetooth® device 29

Listening to audio from a Bluetooth® device 29

Useful features for playback 31

Using a TV's remote control to operate the unit (HDMI control) 31

Showing audio information and function settings 32

Playing audio content using the Sound Bar Controller app	33
Streaming services	33
Playing audio content on your mobile device	33

CONFIGURATIONS **34**

Configuring various functions	34
Changing the brightness of the indicators (Dimmer)	34
Configuring the HDMI control function	35
Configuring HDMI audio output	36
Setting the auto power standby function	37
Enabling/disabling touch panel control (Child Lock function)	38
Enabling/disabling the network standby function	39
Enabling/disabling the wireless (Wi-Fi) function	40
Enabling/disabling the Bluetooth function	40
Updating the unit's firmware	41
Selecting the HDMI signal format	41
Initializing the unit	42
Setting the dynamic range compression	42

APPENDIX **44**

When any problem occurs (General)	44
When any problem occurs (Power and system function)	44
When any problem occurs (Audio)	47
When any problem occurs (Bluetooth®)	49

When any problem occurs (Network trouble)	50
Specifications	52
Specifications	52
Supported HDMI audio and video formats	54
Supported digital audio formats	55
Information for qualified contractors or dealers ...	56
Mounting the unit on a wall	56

INTRODUCTION

Information

Indicates notes on instructions, restrictions on functions, and additional information that may be helpful.

About functions included in the unit

The services that can be used with this unit that are provided by third parties may be changed, suspended, or ended without notice. Please be aware that Yamaha Corporation does not bear any responsibility for these services.

Trademarks

DOLBY AUDIO

Manufactured under license from Dolby Laboratories. Dolby, Dolby Audio, Pro Logic, and the double-D symbol are trademarks of Dolby Laboratories.



For DTS patents, see <http://patents.dts.com>.

Manufactured under license from DTS, Inc. DTS, the Symbol, DTS and the Symbol together, DTS Digital Surround, and DTS Virtual:X are registered trademarks or trademarks of DTS, Inc. in the United States and/or other countries.

© DTS, Inc. All Rights Reserved.



Amazon, Alexa, Amazon Music, Kindle and all related logos are trademarks of Amazon.com, Inc. or its affiliates.

App StoreSM

App Store is a service mark of Apple Inc.



The terms HDMI, the HDMI Logo, and High-Definition Multimedia Interface are trademarks or registered trademarks of HDMI Licensing LLC in the United States and other countries.

x.v.ColorTM

“x.v.Color” is a trademark of Sony Corporation.

AndroidTM Google PlayTM

Android and Google Play are trademarks of Google LLC.



The Wi-Fi CERTIFIEDTM Logo is a certification mark of Wi-Fi Alliance[®].

Wi-Fi and Wi-Fi CERTIFIED are registered trademarks of Wi-Fi Alliance[®].



The Bluetooth® word mark and logos are registered trademarks owned by Bluetooth SIG, Inc. and any use of such marks by Yamaha Corporation is under license.



Spotify and Spotify logo are registered trademarks of the Spotify Group. The Spotify Software is subject to third party licenses found here: www.spotify.com/connect/third-party-licenses

Blu-ray™

“Blu-ray Disc™”, “Blu-ray™”, and the logos are trademarks of the Blu-ray Disc Association.

About content in this manual

- This manual is for the following readers:
 - the users of the unit
 - the constructor, builder and dealer that mount the unit on the wall

- This manual uses the following signal words for the important information:



WARNING

This content indicates “risk of serious injury or death.”



CAUTION

This content indicates “risk of injury.”

NOTICE

Indicates points that you must observe in order to prevent product failure, damage or malfunction and data loss, as well as to protect the environment.

NOTE

Indicates notes on instructions, restrictions on functions, and additional information that may be helpful.

- The illustrations and screens in this manual are for instructional purposes only.
- The company names and product names in this manual are the trademarks or registered trademarks of their respective companies.
- Software may be revised and updated without prior notice.
- In this manual, iOS and Android mobile devices are collectively referred to as “mobile devices”. The specific type of mobile device is noted in explanations as needed.

BEFORE USING THE UNIT

Features

Introduction

This unit is a front surround system with its built-in subwoofers that allows for the enjoyment of superior sound quality from video played on a TV connected to the unit.

■ Play surround sound

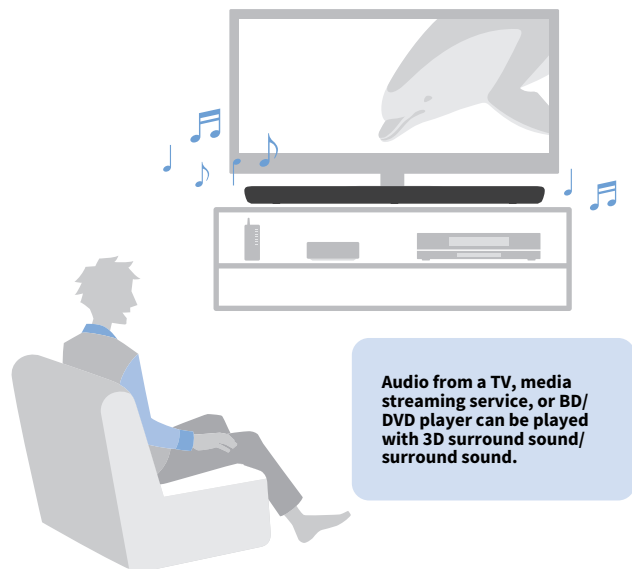

■ Ask Alexa to control the unit

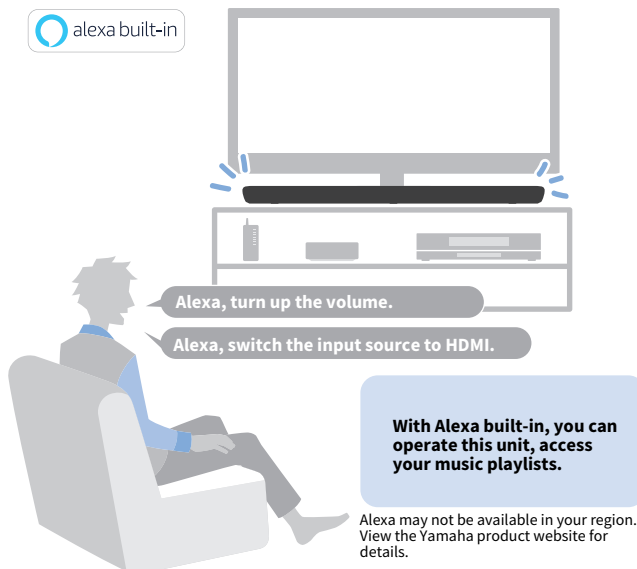

■ Easy operation using the smartphone app

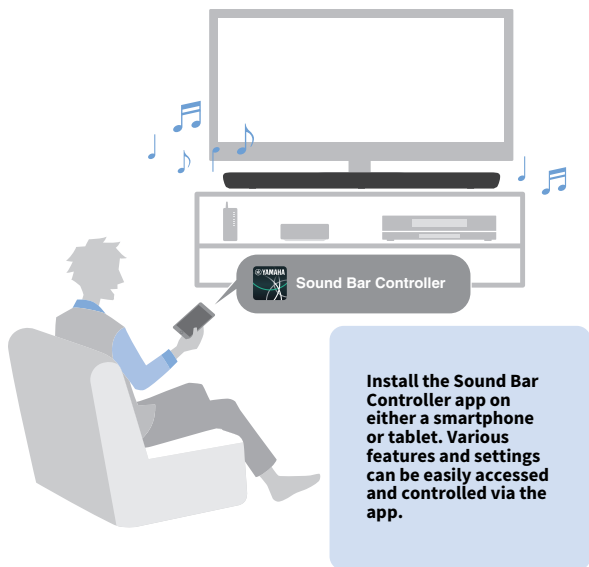

■ Listen to audio from Bluetooth devices and streaming services

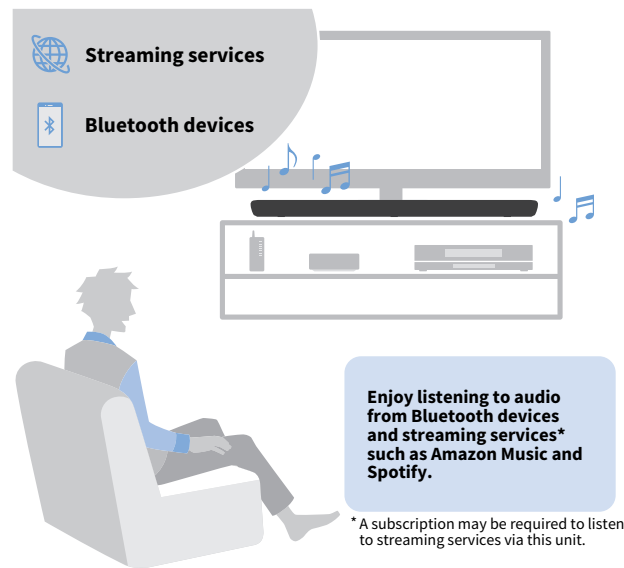

3D surround playback

This unit supports virtual 3D surround sound technology called “DTS Virtual:X”. Surround sound can be heard not only from horizontal directions, but also from varying heights when this unit’s 3D surround mode is enabled, creating a virtual acoustic environment. This ultimately provides an immersive audio and sound experience by creating a sense of sounds not only coming from behind, but also above the listener. For details, see the following:

- “Playback with 3D surround sound/surround sound” (p.27)

Transmission of 4K high dynamic range (HDR) video

Enjoy 4K High Dynamic Range (HDR) content from HDR-compatible sources such as a TV, media streaming device, gaming console, or set-top box. For details, see the following:

- “Supported HDMI audio and video formats” (p.54)

HDMI control function

Link functions of a TV and the unit are available using the TV’s remote control. When a TV that supports Audio Return Channel (ARC) is used, this ARC-compatible unit can be connected to the TV via a single HDMI cable. For details, see the following:

- “Using a TV’s remote control to operate the unit (HDMI control)” (p.31)
- “Connecting a TV that supports Audio Return Channel (ARC)” (p.16)

Bass Extension

The bass extension feature boosts bass levels for more impactful sound. For details, see the following:

- “Enjoying enhanced bass sound (Bass Extension)” (p.28)

Clear Voice

The clear voice function makes speech, such as dialog and narration, clearer. For details, see the following:

- “Playback of human voices clearly (Clear Voice)” (p.28)

Accessories

Checking the accessories

Make sure you have received all of the following accessories.



The unit (YAS-109)



Remote control

A CR2025 Lithium battery has already been inserted into the remote control.



Power cord



Optical digital audio cable



Spacers (x 2/sheet)

Use when mounting the unit on a wall.



Mounting template

Use when mounting the unit on a wall.



Quick Start Guide



Safety Brochure

Using the remote control

Preparing the remote control

Remove the battery insulating strip before attempting to use the remote control.

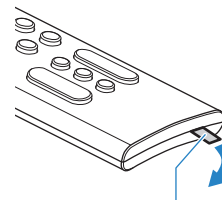

Battery insulating strip

Operating range of the remote control

Operate the remote control within the range shown in the following figure.

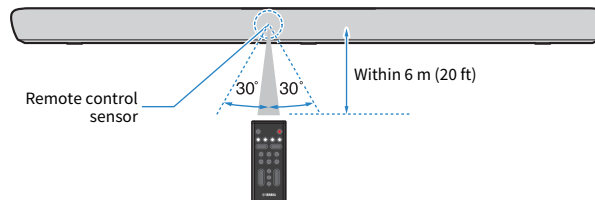

Replacing the battery in the remote control



WARNING

- DO NOT SWALLOW THE BATTERY.
- Keep new and used batteries away from children.
- If the battery compartment does not close securely, stop using the product and keep it away from children.

The remote control supplied with this product contains a coin/button cell battery. If the coin/button cell battery is swallowed, it can cause severe internal burns in just two hours and can eventually lead to death. If you think a battery might have been swallowed or placed inside any part of the body, seek immediate medical attention.



CAUTION

- Do not put in a pocket or bag, carry, or store batteries together with pieces of metal. The battery could short, burst, or leak, causing a fire or injury.
- When storing or discarding batteries, insulate the terminal area by applying tape, or some other protection. Mixing them with other batteries or metal objects can cause a fire, burns, or inflammation due to fluid.

Press and hold  on the rear cover of the remote control, slide the cover out in the direction indicated [1], and replace the old battery with a new one [2]. Slide the rear cover back into place in the direction indicated [3].

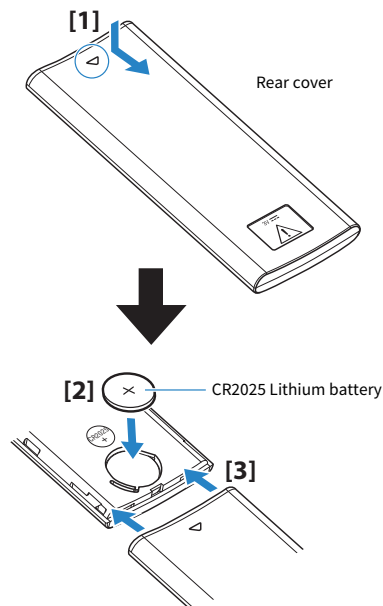

Part names and functions

Part names and functions of the front/top panel

The part names and functions of the front and top panels are as follows.

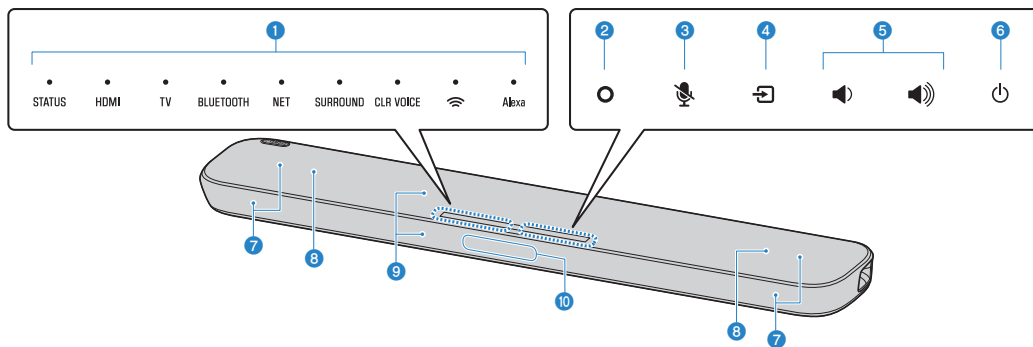

1 Indicators

The indicators on the top panel flash or glow to show the operation and setting status. In this manual, indicator status, such as off, glowing, and flashing, are shown as the illustrations below.

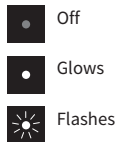

2 ○ (Alexa)

Manually wake Alexa to enable a voice command (p.24).

3 (Microphones disabled)

Touch to disable the microphones. Alexa will not respond to utterances while the microphones are disabled. Disable the microphones to maintain privacy. Touch again to enable the microphones (p.24).

4 (input)

Select an input source (p.22).

5 / (volume +/-)

Adjust the volume (p.22).

6 (power)

Turn on or off the unit.

7 **Speakers**

8 **Dual built-in subwoofers**

The built-in subwoofers are located in the top part of the unit.

9 **Remote control sensor**

Receives infrared (IR) signals from the remote control of the unit (p.9).

10 Microphones

Used to interact with Alexa.

■ NOTICE

- Do not use a vacuum cleaner or aerosol air duster on the microphones when cleaning the unit. Doing so may damage the microphones.

■ NOTE

- 2, 3, 4, 5 and 6 are touch sensors. Touch icons with your finger to control functions.
- Do not place any objects on the touch panel as doing so may result in unintended operations.
- When touch panel control is disabled, no operations can be performed using the unit's touch panel. This prevents accidental operation of the unit. For details, see the following:
 - “Enabling/disabling touch panel control (Child Lock function)” (p.38)
- The brightness of the indicators can be changed using MUSIC on the remote control. For details, see the following:
 - “Changing the brightness of the indicators (Dimmer)” (p.34)

Part names and functions of the rear panel

The part names and functions of the rear panel are as follows.

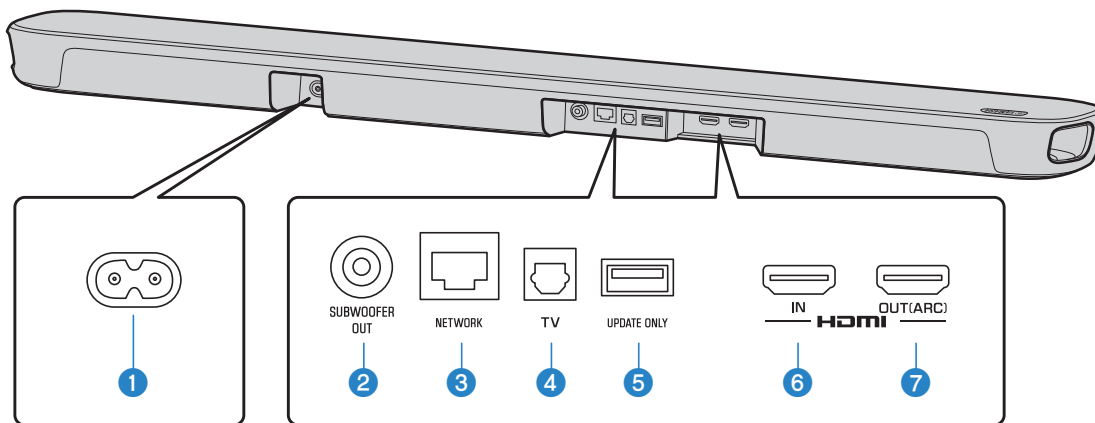

1 Power connector

Connect the power cord (p.18).

2 SUBWOOFER OUT jack

For connecting to an external subwoofer with an RCA mono cable (p.18).

3 NETWORK jack

For connecting to an ethernet cable (sold separately) (p.19).

4 TV input jack

For connecting to a TV that does not support ARC. This jack cannot be used when the unit is connected to an ARC-compatible TV (p.17).

5 UPDATE ONLY jack

Use to update this unit's firmware, if necessary. The jack is located inside the cover.

Refer to the instructions supplied with the firmware for details.

6 HDMI IN jack

For connecting to an HDMI-compatible AV device, such as a BD/DVD player, a satellite and cable TV tuner, and a game console, and inputting video/audio signals (p.17).

7 HDMI OUT (ARC) jack

For connecting to an HDMI-compatible TV and outputting video/audio signals (p.16). When a TV that supports Audio Return Channel (ARC) is used, TV audio signals can also be input through this jack.

Part names and functions of the remote control

The part names and functions of the supplied remote control are as follows.

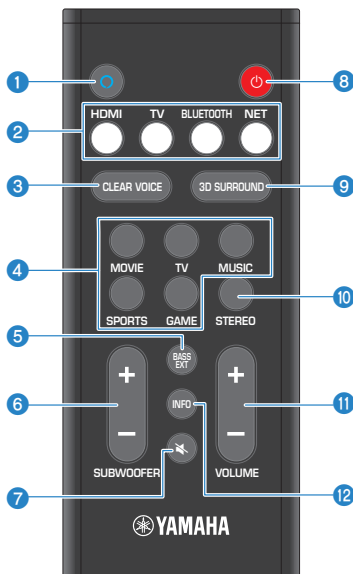

1 (Alexa) button

Manually wake Alexa to enable a voice command (p.24).

2 **Input buttons**

Select an input source to be played back.

- HDMI : Sound from a device connected to the HDMI IN jack (p.17)
- TV : TV audio (p.16)
- BLUETOOTH : Sound from a Bluetooth device (p.29)
- NET : Audio from streaming services (p.33)

3 **CLEAR VOICE button**

Enable/disable the clear voice function (p.28).

4 **Surround mode buttons**

Select a surround mode for 3D surround or surround playback according to your individual preference (p.27).

- MOVIE
- TV
- MUSIC
- SPORTS
- GAME

5 **BASS EXT button**

Enable/disable the bass extension function (p.28).

6 **SUBWOOFER (+/-) button**

Adjust the volume of the subwoofer (p.22).

7 (mute) button

Mute the audio output (p.22). Press the button again to unmute or press VOLUME (+/-).

8 (power) button

Turn on/off the unit.

Turned on



Off

Turned off/network standby (p.39)



Glow (red)

Turned off/Voice Control Ready (p.24)



Glow (white)

9 **3D SURROUND button**

Switch between 3D surround playback and surround playback each time the button is pressed (p.27).

10 **STEREO button**

Switch to stereo (2-channel) playback (p.27).

11 **VOLUME (+/-) button**

Adjust the volume of the unit (p.22).

12 **INFO button**

Confirm the type of audio signal being played, as well as settings for functions (p.32).

PREPARATION

1 Installation

Installing the unit

Install the unit as shown in the following illustration.

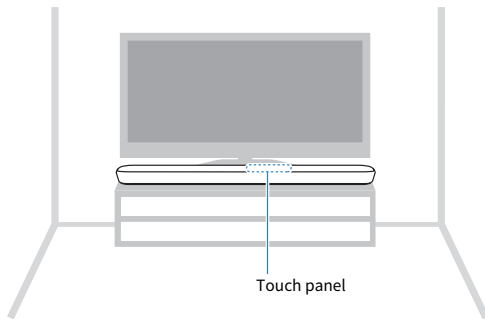

■ NOTICE

- Do not stack the unit and any other device directly on each other. Doing so may cause a malfunction due to vibrations.
- Do not apply excessive force to the unit when moving it. Doing so may damage the speakers or the portion covered with fabric.
- The unit contains non-magnetic shielding speakers. Do not place magnetically sensitive items (hard disk drive, etc.) near the unit.

■ NOTE

The unit can also be mounted on a wall. For details, see the following:

- “Mounting the unit on a wall” (p.56)

2 Connecting a TV

Connecting a TV that supports Audio Return Channel (ARC)

Connect the TV, which supports Audio Return Channel (ARC), to the unit with an HDMI cable (sold separately).

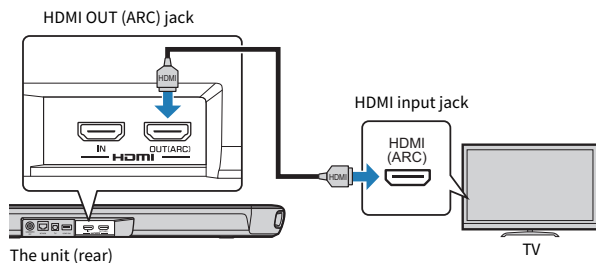

■ What is Audio Return Channel (ARC)?

In order for the unit to play audio from a TV, the TV must usually be connected to the unit via an audio cable as well as an HDMI cable. If, however, the TV supports Audio Return Channel (ARC), TV audio signals can be input to the unit via the HDMI cable that outputs video signals from the unit to the TV.

■ NOTE

- Connect an HDMI cable to the audio return channel supported jack (the jack with “ARC” indicated) on TV.
- Enable the HDMI control function of the unit to activate the Audio Return Channel (ARC). For details, see the following:
 - “Configuring the HDMI control function” (p.35)
- Use a 19-pin HDMI cable with the HDMI logo printed on it.
- Keep the cable as short as possible to prevent any degradation in signal quality.
- Use a premium high-speed HDMI cable for playback of 3D and 4K video content.
- The TV input jack cannot be used when a TV that supports the Audio Return Channel is connected to the unit.

Connecting a TV that does not support Audio Return Channel (ARC)

Connect the TV to the unit with an HDMI cable (sold separately) and an optical digital audio cable (supplied).

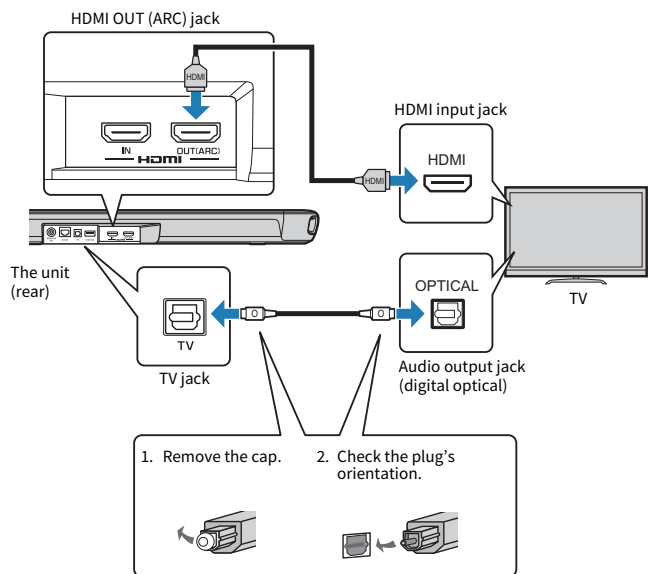

■ NOTE

- Use a 19-pin HDMI cable with the HDMI logo printed on it.
- Keep the cable as short as possible to prevent any degradation in signal quality.
- Use a premium high-speed HDMI cable for playback of 3D and 4K video content.

3 Connecting AV devices

HDMI connection with an AV device

Connect an AV device such as a media streaming device to the unit with an HDMI cable (sold separately).

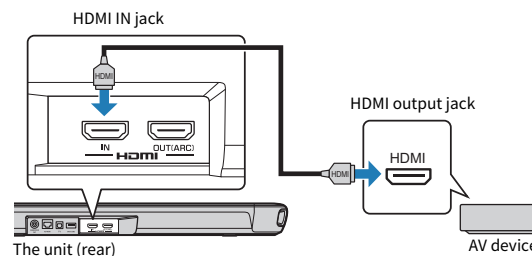

■ NOTE

- Once the HDMI control function has been activated, video and audio signals from AV devices can be output from the TV even when the unit is turned off (HDMI signal pass-through). For details, see the following:
 - “Configuring the HDMI control function” (p.35)
- Use a 19-pin HDMI cable with the HDMI logo printed on it.
- Keep the cable as short as possible to prevent any degradation in signal quality.
- Use a premium high-speed HDMI cable for playback of 3D and 4K video content.

4

Connecting an external subwoofer

Connecting an external subwoofer

The unit has dual built-in subwoofers; however you can connect a subwoofer equipped with built-in amplifier when you want to enhance low frequency sound.

Connect an external subwoofer to the unit via an RCA mono cable (sold separately).

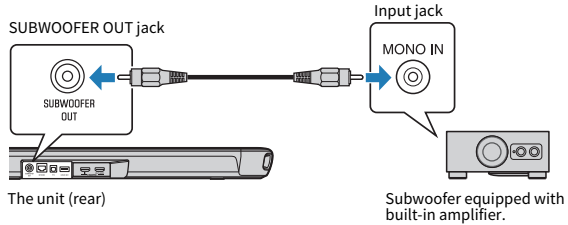

■ NOTE

Sound is output from both the built-in subwoofers and external subwoofer.

5

Connecting to power

Connecting to power

Once all connections have been made, connect the unit to power as shown in the following illustration.

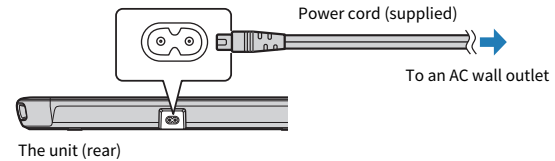

6 Connecting to a network

Network functions

A network connection allows you to play various streaming services via the unit, and to talk with Amazon Alexa to operate this unit, or to play music.

The Sound Bar Controller app for mobile devices is required to configure and operate network functions.

■ NOTICE

- Do not connect this product to public Wi-Fi or Internet directly. Only connect this product to the Internet through a router with strong password-protections. Consult your router manufacturer for information on security best practices.

■ NOTE

- To use network function, the unit and mobile device must be connected to the same router.
- When using a multiple SSID router, access to the unit might be restricted depending on the SSID to connect. Connect the unit and mobile device to the same SSID.
- Some security software installed on your computer, or network device settings (such as a firewall), may block the unit's access to streaming services. Should this occur, change security software and/or network device settings.
- A network connection cannot be established if the MAC address filter on your router is enabled. Check your router's settings.
- To configure your router's subnet mask manually, apply the same subnet used by this unit to all devices.
- Use of a broadband connection is recommended when using Internet services.
- The unit cannot be connected to a network that requires manual setup. Connect the unit to a DHCP enabled router.

Wired network connections

To use a wired network connection, connect the unit to a router via an STP ethernet cable (CAT-5 or higher straight cable).

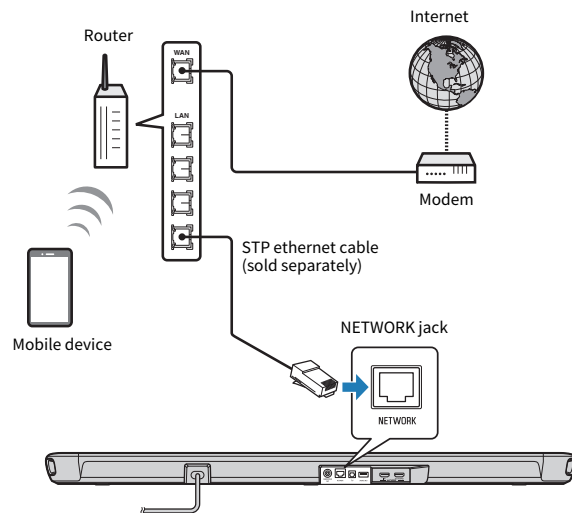

Wireless network connections

Connect the unit to a wireless router (access point) to use a network. See the following for instructions on connecting to a wireless router (access point).

- “Connecting to a network with the Sound Bar Controller app” (p.20)

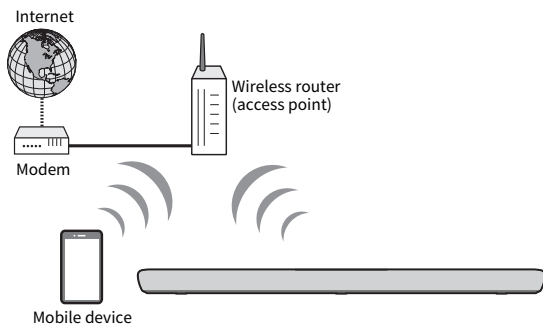

■ NOTE

- If the unit and the wireless router (access point) are too far apart, the unit may not connect to a wireless router (access point). In such case, place them close to each other.
- This unit operates only in the 2.4-GHz band. Connect your mobile device to the network using the 2.4-GHz band and then configure the unit's settings for a wireless connection.

Connecting to a network with the Sound Bar Controller app

Install the Sound Bar Controller app on your mobile device to connect the unit to a network.

■ NOTE

- Confirm that your mobile device is connected to your home router before beginning.
- Screen displays are provided for reference purposes only. Actual screen displays may differ depending upon the mobile device used.
- Sound Bar Controller app screens and menu labels are subject to change without prior notice.

1 Install the Sound Bar Controller app on your mobile device, and then open the app.

Search for “Sound Bar Controller” on the App Store or Google Play.

2 Follow the app's on-screen instructions to complete the settings.

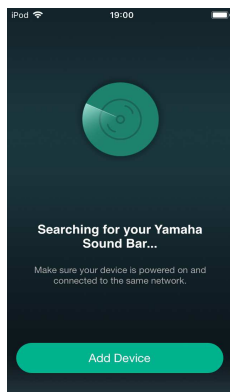

The  indicator on the unit glows when the unit is connected to a wireless network.



■ NOTE

When the unit is connected to a network for the first time after purchase, the unit's firmware is updated to the latest firmware version.

PLAYBACK

Basic operations

Basic procedure for playback

Basic procedure for playing back music is as follows.

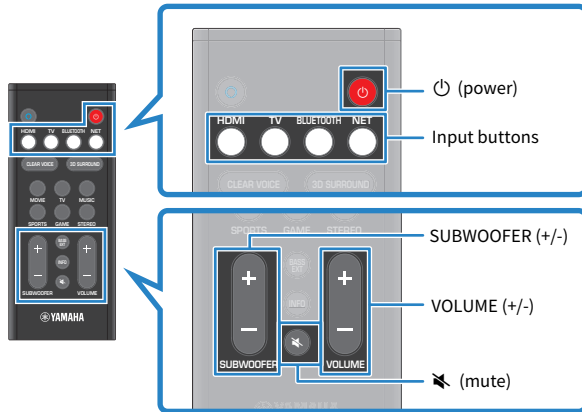

- 1 Press to turn on the unit.
- 2 Turn on the external devices (such as a TV, BD/DVD player, and gaming console) connected to the unit.

- 3 Use the input buttons to directly select an input source to be played.

HDMI: Sound from a device connected to the HDMI IN jack

TV: TV audio

BLUETOOTH: Sound from a Bluetooth device

NET: Audio from streaming services

The indicator for the selected input source glows.

Example
When TV is selected

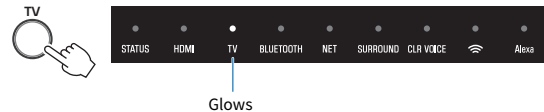

- 4 Start playback on the external device selected in step 3.

5 Press VOLUME (+/-) to adjust the volume.

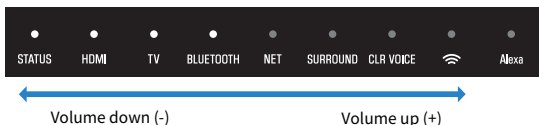

The number of glowing indicators (other than the Alexa indicator) increases or decreases as volume is raised or lowered.



When audio is output from both TV speaker and the unit, mute the TV sound.

6 Adjust sound settings to suit individual preferences.

■ NOTE

- For details on adjusting sound settings, see the following:
 - “Playback with 3D surround sound/surround sound” (p.27)
 - “Playback with 2-channel stereo sound” (p.27)
 - “Playback of human voices clearly (Clear Voice)” (p.28)
 - “Enjoying enhanced bass sound (Bass Extension)” (p.28)
- For details on playing music files stored on a Bluetooth device, see the following:
 - “Listening to audio from a Bluetooth® device” (p.29)
- For details on playing audio from streaming services, see the following:
 - “Streaming services” (p.33)
- To mute the sound, press . Press  again or VOLUME (+/-) to unmute.



Flash (on mute)

- When sound input to the HDMI IN jack is output from the TV, the volume level does not change even if you press VOLUME (+/-) or .
- To adjust the subwoofer volume, press SUBWOOFER (+/-). The subwoofer volume can be adjusted separately from the whole volume. The indicator (other than the Alexa indicator) that glows changes as volume is raised or lowered.



- When playing audio/video from a device connected to the TV, select TV as the unit’s input source, and select the playback device with the input selector on the TV.

Operating the unit using voice commands (Amazon Alexa)

You can talk to Amazon Alexa on your unit. With Alexa, you can ask to play music, hear the news, check weather, control smart home devices, and more.

An Amazon account is required to use Amazon Alexa and the unit must be connected to a network. Use the Sound Bar Controller app to enter your Amazon account information and log into the service.

Alexa can perform the following operations with the proper voice commands.

- Switching input sources
- Adjusting (muting) the volume
- Selecting and listening to streaming services
See the following website for details on the supported streaming services:
<https://manual.yamaha.com/av/sb/ss/sbc/>



■ NOTE

- As of August 2019, Amazon Alexa supports the following languages: English, German and French.
- Service is limited to certain areas.
- Services supported by the unit may not be available in some regions in which the unit is sold.
- See the product information page on the Yamaha website for the latest information.
- A subscription may be required to listen to Amazon Music or Amazon Kindle on this unit. For more information, visit the Amazon website.
- For information on other streaming services, visit the websites of those service providers.
- A smart hub (sold separately) may be required to connect smart home devices that will be controlled via the unit.

For example, just ask:







- **Adjust the volume**
“Alexa, turn up the volume.”
“Alexa, turn down the volume.”
- **Switch input sources**
“Alexa, switch the input source to HDMI.”
- **Listen to streaming content from Amazon Music**
“Alexa, play some jazz music.”
- **Operate playback**
“Alexa, play next song.”
“Alexa, stop the music.”
“Alexa, what is this song?”
- **Check the weather**
“Alexa, what's the weather?”
- **Set a timer**
“Alexa, set a timer for 10 minutes.”



■ NOTE

- Amazon Alexa is a service provided by Amazon. This service may change, be discontinued, or be terminated without notice. Please note that Yamaha Corporation is in no way responsible for the continuation of this service, and will not be held liable for any issues that arise from the use of this service.
- This service is limited to certain areas.
- This service may not be available in some countries or regions.
- Some functions require a third party service agreement.
- To prevent accidental or mistaken response from Alexa, or to maintain privacy, touch  on this unit to disable the microphones.
- Alexa can be activated or summoned by calling out, “Alexa,” or by pressing  on the remote control or touching  on the unit.
- When the Voice Control Ready function is enabled, Alexa can accept voice commands even when the unit is turned off. Use the Sound Bar Controller app to enable or disable the Voice Control Ready function.
- The dedicated Amazon Alexa app for mobile devices provided by Amazon allows you to configure detailed settings and add functions. For details, see the Amazon Alexa app help guide.

■ Alexa indicator

The Alexa indicator on this unit glows depending on the status of Alexa, as follows.

Examples of Alexa indicator activity	Status of Alexa
 Alexa Goes off	Idle
 Alexa Glowing pale blue	Listening to a request
 Alexa Flashing blue	Processing a request
 Alexa Flashing blue and pale blue slowly	Responding
 Alexa Flashing blue and pale blue quickly	Notifications such as timers, alarms, and reminders
 Alexa Flashing yellow	A notification is received.

Examples of Alexa indicator activity	Status of Alexa
 <p data-bbox="221 227 304 247">Glow red</p>	<p data-bbox="410 182 654 202">The microphones are disabled.</p>
 <p data-bbox="221 349 304 369">Glow orange</p>	<p data-bbox="410 304 632 324">A system setting is changed.</p>
 <p data-bbox="165 471 357 491">Flashing red three times</p>	<p data-bbox="410 426 552 446">An error occurred.</p>

Enjoying your favorite sound

Playback with 3D surround sound/ surround sound

The unit switches between 3D surround playback and surround playback each time 3D SURROUND is pressed. Select 3D surround playback or surround playback according to the input source or your individual preference.

When 3D surround playback is selected, DTS Virtual:X makes it possible to hear sound not only from horizontal directions, but also from varying heights.

3D surround playback



Glow (blue): 3D surround playback

Surround playback



Glow (white): surround playback

Selecting a surround mode

Select the surround mode best suited to the content by pressing MOVIE, TV, MUSIC, SPORTS, or GAME with 3D surround playback or surround playback enabled.

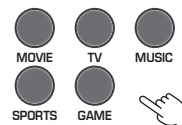

Playback with 2-channel stereo sound

Press STEREO to switch to 2-channel stereo playback according to the input source or your individual preference.

When stereo playback is enabled, the SURROUND indicator goes off.



Playback of human voices clearly (Clear Voice)

Press CLEAR VOICE to turn on the clear voice function. Human voices such as dialogue in movies, TV shows, news, and sport commentary can be heard clearly.

Press the button again to disable the function. The indicators will go off.

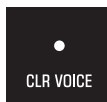

Glow

Enjoying enhanced bass sound (Bass Extension)

Press BASS EXT to turn on the bass extension function. You can enjoy enhanced bass sound and more powerful sound.

Press the button again to disable the function.



Flash three times (enabled)
Flash once (disabled)

■ NOTE

Press INFO to confirm whether the bass extension function is enabled or disabled. For details, see the following:

- “Showing audio information and function settings” (p.32)

Using a Bluetooth® device

Listening to audio from a Bluetooth® device

Audio content from a Bluetooth device (such as a smartphone, tablet, laptop, or digital music player) can be played through this unit over a wireless connection.

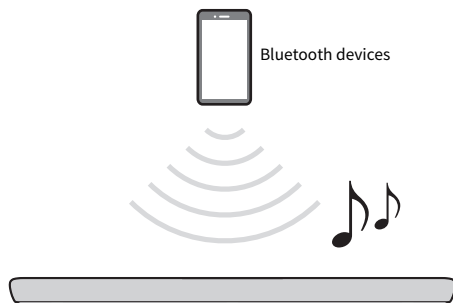

■ NOTE

- Our exclusive Compressed Music Enhancer technology improves sound quality and characteristics, and can be used to enjoy realistic and impressive sound.
- The network standby function is enabled by default. When a Bluetooth device is connected to this unit while the unit is off, the unit will be turned on and will be immediately ready to play sound from the Bluetooth device. For details, see the following:
 - “Enabling/disabling the network standby function” (p.39)

1 Press **BLUETOOTH** to select “Bluetooth” as the input source.

The unit is ready for the Bluetooth connection, and the **BLUETOOTH** indicator on the unit flashes.

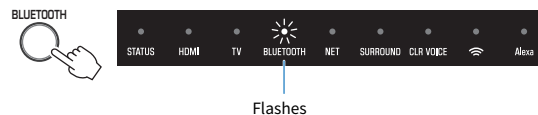

■ NOTE

If Bluetooth devices have been connected before, the unit will connect to the last connected device when **BLUETOOTH** is pressed.

2 On the Bluetooth device, enable the Bluetooth function.

The Bluetooth device list appears on the Bluetooth device.

3 Select this unit in the list.

The unit's name is displayed as shown in the following illustration.

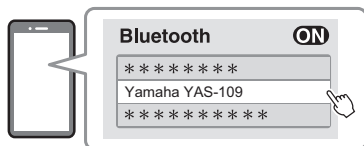

When the connection between the Bluetooth device and the unit is established, a completion message is displayed on the Bluetooth device, and the BLUETOOTH indicator on the unit glows.



Glow

4 Play content with audio on the Bluetooth device.

The unit will begin playing audio from the Bluetooth device.

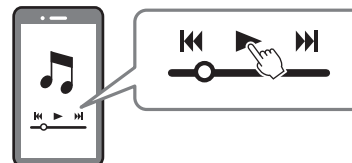

■ NOTE

- To terminate the Bluetooth connection, perform one of the following operations.
 - Turn off the Bluetooth function on the Bluetooth device.
 - Hold down BLUETOOTH for at least five seconds.
 - Select an input source other than Bluetooth on the unit.
 - Turn off the unit.
- Adjust the volume level of the Bluetooth device as required.
- Perform Bluetooth connection with the Bluetooth device and unit within 10 m (33 ft) of each other.
- See documentation supplied with your Bluetooth device for more information.

Useful features for playback

Using a TV's remote control to operate the unit (HDMI control)

The HDMI control function coordinates TV and unit operation so that the unit can be operated using the TV's remote control.

When the unit is connected to a TV via HDMI cable, the TV's remote control can be used to perform the following operations.

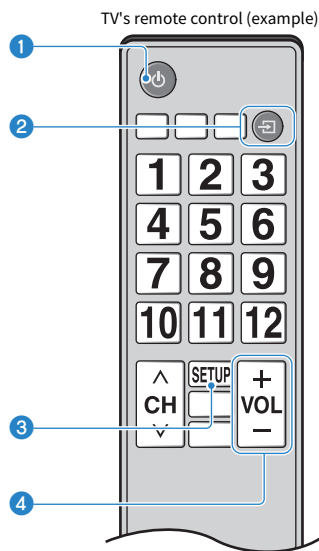

1 Turn on/off

Both the TV and the unit turn on/off at the same time.

2 Switch input sources

The unit's input source switches accordingly when the TV's input source is switched.

For example, when a TV program is selected on the TV, the unit's audio input source is switched to the HDMI OUT (ARC) jack using the ARC function or TV input jack.

When a BD/DVD player is connected to the HDMI IN jack on the unit, the unit's input source switches to HDMI when the BD/DVD player is selected with the TV's remote control.

3 Switch the audio output device

The audio output device can be switched to the TV or this unit. Operations may differ depending upon TVs.

4 Adjust volume

The unit's volume can be adjusted when the TV's audio output is set to the unit.

■ NOTE

- If you are unable to operate the unit with your TV's remote control, configure the HDMI control function of your TV and the unit. For details, see the following:
 - “Configuring the HDMI control function” (p.35)
- The input source can be switched while the unit is off (HDMI signal pass-through).
- The volume displays on the TV and unit may not be the same.

Showing audio information and function settings

The type of audio signal being played, as well as settings for functions can be confirmed by the status of indicators.

1 Press INFO.

The indicators on the unit will show the following audio information for three seconds immediately after INFO is pressed.

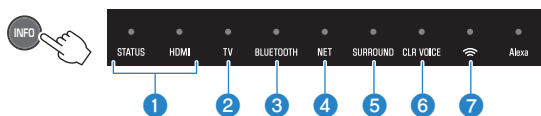

1 Show the type of audio signal.

STATUS glows (white): Dolby Digital

STATUS glows (red): DTS

STATUS and HDMI off: PCM/no input

2 Show whether Dolby Pro Logic II is enabled or disabled.

Glows: Enabled

Off: Disabled

■ NOTE

Dolby Pro Logic II is enabled automatically when 2-channel stereo signals are played in surround sound.

3 Show the bass extension function setting.

Glows: Enabled

Off: Disabled

4 Show the Bluetooth function setting.

Glows: Enabled

Off: Disabled

■ NOTE

The Bluetooth function setting is not shown while audio content is playing from a Bluetooth device or over a network.

5 Show the dynamic range compression setting

Glows (blue): Compression (maximum)

Glows (white): Compression (standard)

Off: No compression

6 Show the wireless (Wi-Fi) function setting.

Glows: Enabled

Off: Disabled

7 Show touch panel control setting

Glows: Enabled

Off: Disabled

Playing audio content using the Sound Bar Controller app

Streaming services

Audio content distributed by various streaming services over the Internet can be played via the unit. Use the dedicated app for mobile devices provided by a particular streaming service or talk to Amazon Alexa to select content to play from a streaming service. See the product information page on the Yamaha website for information on services supported by the unit.

For additional information on the streaming services, see the following website.

<https://manual.yamaha.com/av/sb/ss/sbc/>

■ NOTE

- A subscription may be required to listen to streaming services via this unit. For information on a particular streaming service, visit that service's website.
- Service is limited to certain areas.
- Services supported by the unit may not be available in some regions in which the unit is sold.
- Services may change or be discontinued without notice. Please note that Yamaha Corporation is in no way responsible for, and will not be held liable for, streaming services or issues arising from their use.

Playing audio content on your mobile device

Play audio content on your mobile device over a network. Use the Sound Bar Controller app installed on your mobile device to play audio content. See the Sound Bar Controller app for details.

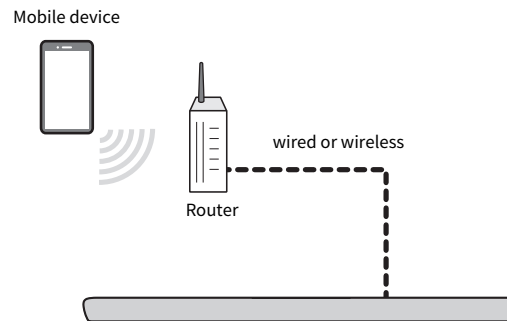

CONFIGURATIONS

Configuring various functions

Changing the brightness of the indicators (Dimmer)

Change the brightness of the indicators on the unit.

The brightness is dim by default.

- 1 Turn off the unit.**
- 2 Press and hold MUSIC for at least five seconds.**

The brightness setting of the indicators is changed.



Once the indicators have shown the brightness setting applied to the unit as follows, the unit will turn on.

- Dim (default setting)



- Off

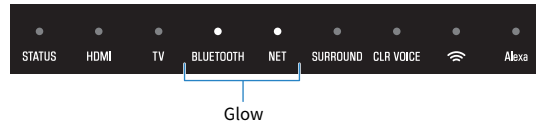

- Bright

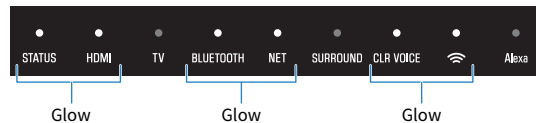

■ NOTE

Indicators glow brightly just after operation and change to the specified brightness after a few seconds.

Configuring the HDMI control function

Enable or disable the unit's HDMI control function (link function). This function coordinates TV and unit operation so that the unit can be operated using the TV's remote control.

This function is enabled by default.

1 Turn off the unit.

2 Press and hold HDMI for at least five seconds.

The HDMI control function is enabled or disabled.



Once the indicator has shown the HDMI control function setting applied to the unit as follows, the unit will turn on.

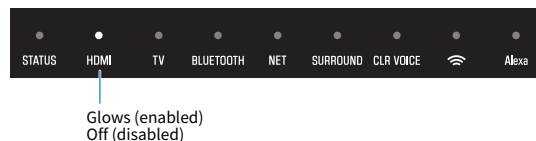

■ NOTE

- Enable the HDMI control function when connecting a TV that supports Audio Return Channel (ARC), or when using HDMI signal pass-through. For details, see the following:
 - “Connecting a TV that supports Audio Return Channel (ARC)” (p.16)
 - “HDMI connection with an AV device” (p.17)
- If the unit cannot be operated with the TV's remote control, confirm that the HDMI control function of this unit is enabled and the HDMI control function is enabled on the TV. For details, see the following:
 - “The unit cannot be operated using the TV's remote control” (p.46)
- The unit's power consumption will be reduced if the HDMI control function is disabled.

Configuring HDMI audio output

Select the device from which audio input via the unit's HDMI IN jack will be played when the HDMI control function is disabled. HDMI audio is output from this unit by default.

The unit (default)	Play HDMI audio input signal from the unit.
TV	Play HDMI audio input signal from the TV.

1 Turn off the unit.

2 Press and hold 3D SURROUND for at least five seconds.

The HDMI audio output setting is changed.



Once the indicator has shown the HDMI audio output setting applied to the unit as follows, the unit will turn on.



Glows (audio is played from the unit)
Off (audio is played from the TV)

■ NOTE

- When playing back HDMI audio input signal from the TV, the unit cannot be used to adjust volume. Use TV controls to adjust volume.
- For details on the HDMI control function, see the following:
 - “Configuring the HDMI control function” (p.35)
- To configure HDMI audio output with the HDMI control function enabled, select the audio output device on the TV connected to the unit.
- HDMI video signals input to the HDMI IN jack of this unit are always output from the HDMI OUT (ARC) jack of the unit.

Setting the auto power standby function

Enabling the auto power standby function prevents the unit from remaining on when not in use. When the auto power standby function is enabled, the unit automatically turns off in any of the following situations.

- No operations for 8 hours
- No audio input and no operations for 10 minutes

This function is enabled by default.

1 Turn off the unit.

2 Touch and hold  and then touch and hold  on the unit for at least five seconds.

The auto power standby function is enabled or disabled.



Once the indicator has shown the auto power standby function setting applied to the unit as follows, the unit will turn on.

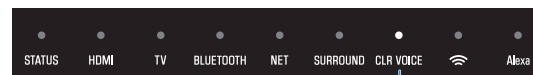

Glows (disabled)
Off (enabled)

Enabling/disabling touch panel control (Child Lock function)

Disable touch panel control to prevent children from accidentally operating the unit.

Touch panel control is enabled by default.

1 Turn off the unit.

2 Press and hold INFO for at least five seconds.

The touch panel control is enabled or disabled.



Once the indicator has shown the touch panel control setting applied to the unit as follows, the unit will turn on.



Glows (enabled)
Off (disabled)

■ NOTE

Press INFO to confirm whether the child lock function is enabled or disabled. For details, see the following:

- “Showing audio information and function settings” (p.32)

Enabling/disabling the network standby function

Enabling the network standby function allows the unit to be turned on or off using a mobile or Bluetooth device as follows.

This function is enabled by default.

- The unit can also be turned on and off using the Sound Bar Controller app installed on your mobile device.
- When a Bluetooth device is connected to this unit while it is off, this unit turns on and the input source switched to BLUETOOTH.

1 Turn off the unit.

2 Press SPORTS for at least five seconds.

The network standby function is enabled or disabled.



Once the indicator has shown the network standby function setting applied to the unit as follows, the unit will turn on.



Glow (enabled)
Off (disabled)

■ NOTE

The unit consumes more power when it is off with the network standby function enabled than it does when it is off with this function disabled.

Enabling/disabling the wireless (Wi-Fi) function

Enable or disable the wireless (Wi-Fi) function.
This function is enabled by default.

- 1 Turn off the unit.**
- 2 Press and hold NET for at least five seconds.**

The wireless (Wi-Fi) function is enabled or disabled.



Once the indicator has shown the wireless (Wi-Fi) function setting applied to the unit as follows, the unit will turn on.

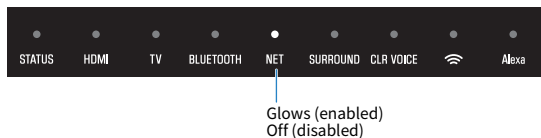

■ NOTE

Press INFO to confirm whether the wireless (Wi-Fi) function is enabled or disabled. For details, see the following:

- “Showing audio information and function settings” (p.32)

Enabling/disabling the Bluetooth function

Enable or disable the Bluetooth function.
This function is enabled by default.

- 1 Turn off the unit.**
- 2 Press and hold BLUETOOTH for at least five seconds.**

The Bluetooth function is enabled or disabled.



Once the indicator has shown the Bluetooth function setting applied to the unit as follows, the unit will turn on.

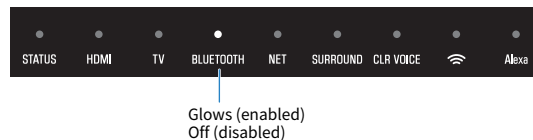

■ NOTE

Press INFO to confirm whether the Bluetooth function is enabled or disabled. For details, see the following:

- “Showing audio information and function settings” (p.32)

Updating the unit's firmware

New firmware that provides additional features or product improvements will be released as needed. Firmware can be updated using the Sound Bar Controller app installed on a mobile device.

■ NOTICE

- Do not operate the unit or disconnect the power cord or network cable during firmware update.
- If the Internet connection speed is slow, or the unit is connected to the wireless network, network update may not be possible depending on the condition of the network connection. Should this occur, try again at a later time.
- For details on update, visit the Yamaha website.

When a new firmware is released, a “NEW” icon is displayed on the screen of the Sound Bar Controller app. Tap the icon, then follow the on-screen instructions to update the firmware.

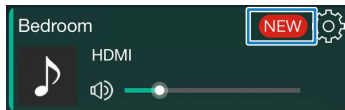

Selecting the HDMI signal format

Problems such as a lack of sound or the appearance of abnormal colors in a video may occur when some AV devices are connected to the unit. Should this occur, changing the setting may resolve these issues.

Mode 1 (default)	Select this mode in most cases.
Mode 2	Select this mode if problems such as the appearance of abnormal colors in video have occurred.

- 1 Turn on the unit.**
- 2 Press STEREO for at least five seconds.**





Once the indicator has shown the setting applied to the unit as follows, the unit will turn on.



Glows (mode 1)
Off (mode 2)

Initializing the unit

Reset the settings of the unit to the factory presets.

- 1 Turn off the unit.**
- 2 Touch and hold  and  on the unit until all indicators except the Alexa indicator flash.**

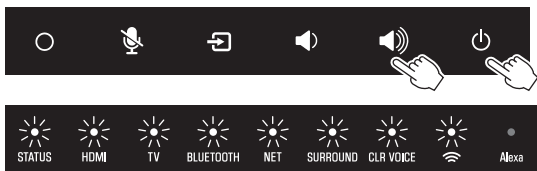





Flash (initialized)

Setting the dynamic range compression



Select the dynamic range compression level.

This function is set to “No compression” by default.

- 1 Turn off the unit.**
- 2 Use the remote control to select the desired compression level.**

Compression level	Function	Operations (buttons must be pressed consecutively within three seconds.)
Compression (maximum)	Apply the maximum amount of dynamic range compression.	STEREO, VOLUME (+), and then 
Compression (standard)	Apply the standard amount of dynamic range compression for normal home use.	STEREO, VOLUME (-), and then 
No compression	Dynamic range compression is not applied.	STEREO,  , and then 

The indicators show the compression level applied for several seconds.

Compression level	Indicators
Compression (maximum)	
Compression (standard)	 <p data-bbox="300 386 416 408">Glow (white)</p>
No compression	 <p data-bbox="323 535 432 557">Glow (white)</p>

■ NOTE

Press INFO to confirm the dynamic range compression level applied to the unit. For details, see the following:

- “Showing audio information and function settings” (p.32)

APPENDIX

When any problem occurs (General)

Check the following first:

Refer to the following when the unit does not function properly.

- The power cords of the unit, TV and AV devices are connected to AC wall outlets securely.
- The unit, TV and AV devices are turned on.
- The connectors of each cable are securely inserted into jacks on each device.

If there is no problem with the power and cables, see the following:

- “When any problem occurs (Power and system function)” (p.44)
- “When any problem occurs (Audio)” (p.47)
- “When any problem occurs (Bluetooth®)” (p.49)

If the problem you are experiencing is not listed or if the instructions do not help, turn off the unit, disconnect the power cord, and contact the nearest authorized Yamaha dealer or service center.

When any problem occurs (Power and system function)

The power turns off suddenly

● The auto power standby function activated.

When the auto power standby function is enabled, the unit automatically turns off in any of the following situations:

- No operations have been performed for 8 hours
- No audio has been input to the unit or no operations have been performed with the unit for more than 10 minutes.

Turn on the unit again. If the auto power standby function is not used, disable the function. For details, see the following:

- “Setting the auto power standby function” (p.37)

● The protection circuitry has been activated. (The STATUS indicator flashes white or red.)

After confirming that all connections are made properly, turn on the unit again. If the power still turns off frequently, unplug the power cord from the AC wall outlet and contact the nearest authorized Yamaha dealer or service center.

The power cannot be turned on

- **The protection circuitry has been activated three times consecutively.**

To protect the product, the power cannot be turned on. Unplug the power cord from the AC wall outlet and contact the nearest authorized Yamaha dealer or service center.

- **The firmware has not been updated properly. (The  indicator is flashing.)**

Use a USB flash drive to update the firmware. For details, see the product information page on the Yamaha website.

- Product information page > Support (Download) > Firmware/Software

No operations can be performed from the unit's touch panel

- **The touch panel control is disabled.**

Enable the touch panel control. For details, see the following:

- “Enabling/disabling touch panel control (Child Lock function)” (p.38)

All indicators go out although the unit is turned on (it may seem that the unit is turned off)

- **Indicator brightness is configured so that they do not light.**

Change the brightness. For details, see the following:

- “Changing the brightness of the indicators (Dimmer)” (p.34)

The unit does not function correctly

- **The internal microcomputer is frozen due to an external electric shock (such as lightning or excessive static electricity) or to a drop in the power supply voltage.**

Unplug the power cord from the AC wall outlet and plug it again.

The unit turns on by itself

- **Another Bluetooth device is being operated nearby.**

Terminate Bluetooth connection with the unit. For details, see the following:

- “Listening to audio from a Bluetooth® device” (p.29)

The TV's 3D glasses do not work

- **The unit is blocking the TV's 3D glasses transmitter.**

Confirm the position of the TV's 3D glasses transmitter and position the unit so that it does not obstruct the transmitter.

HDMI video is not displayed correctly on TV screen

- **The HDMI cable is not securely connected.**

Connect the HDMI cable properly. For details, see the following:

- “Connecting a TV that supports Audio Return Channel (ARC)” (p.16)
- “Connecting a TV that does not support Audio Return Channel (ARC)” (p.17)

- **A communication error between the unit and connected device has occurred.**

A communication error may occur depending upon the generation of the device connected to the unit. See the following if such an error occurs:

- “Selecting the HDMI signal format” (p.41)

- **The TV does not support HDCP version 2.2/2.3.**

Connect the unit to the HDMI input jack on an HDCP v2.2/2.3-compliant TV when playing video content that requires an HDCP v2.2/2.3-compliant device.

- **The unit is connected to an HDMI input jack on the TV that does not support HDCP v2.2/2.3.**

Connect the unit to an HDMI input jack on the TV that supports HDCP v2.2/2.3 when playing video content that requires an HDCP v2.2/2.3-compliant device.

When the unit is turned off, video and/or audio from an AV device are not output to the TV

- **The HDMI control function is disabled.**

Enable the HDMI control function. For details, see the following:

- “Configuring the HDMI control function” (p.35)

The unit cannot be operated using the remote control

- **The unit is out of the operating range.**

Use the remote control within the operating range. For details, see the following:

- “Operating range of the remote control” (p.9)

- **The batteries are weak.**

Replace with new batteries. For details, see the following:

- “Replacing the battery in the remote control” (p.10)

- **The remote control sensor of the unit is exposed to direct sunlight or strong lighting.**

Adjust the lighting angle or reposition the unit.

The TV cannot be operated using the TV’s remote control

- **The unit is blocking the TV’s remote control sensor.**

Position the unit so that it does not obstruct the TV’s remote control sensor.

The unit cannot be operated using the TV’s remote control

- **The HDMI control function is incorrect.**

Confirm the settings are properly configured as follows.

- The HDMI control function of the unit is enabled.
- The HDMI control function is enabled on the TV.
- Set audio output to any option other than TV.

If the unit cannot be operated with the TV’s remote control, even after the settings have been applied correctly:

- Turn off the unit and the TV, and then turn them back on again.
- Disconnect the power cord of the unit and external devices connected to the unit via HDMI cable. Plug them in again after about 30 seconds.

- **The TV does not support the unit's functions.**

Even if your TV supports the HDMI control function, some functions may not be available. For details, see documentation supplied with your TV.

Alexa will not operate the unit

- **Alexa is not properly configured.**

Use the Sound Bar Controller app to configure Alexa. For details, see the following:

- “Operating the unit using voice commands (Amazon Alexa)” (p.24)

- **The unit is not connected to a network.**

Connect the unit to a network. For details, see the following:

- “Connecting to a network with the Sound Bar Controller app” (p.20)

Alexa does not respond when summoned.

- **The microphones are disabled.**

Touch  to enable the microphones.

When any problem occurs (Audio)

No sound

- **Another input source is selected.**

Select an appropriate input source. For details, see the following:

- “Basic procedure for playback” (p.22)

- **The mute function is activated.**

Cancel the mute function. For details, see the following:

- “Basic procedure for playback” (p.22)

- **The volume is too low.**

Turn up the volume. For details, see the following:

- “Basic procedure for playback” (p.22)

- **The power cord of the unit is not connected properly.**

Make sure that the power cord of the unit is securely connected to an AC wall outlet. For details, see the following:

- “Connecting to power” (p.18)

- **Input jacks on an AV device are connected.**

Connect the input jack on the unit and the output jack on the AV device.

- **Signals that the unit cannot play back are being input.**

Change the digital audio output setting on the AV device to PCM, Dolby Digital, or DTS.

- **The unit is configured so that HDMI audio input signals are output from the TV.**

Configure the unit so that HDMI audio input signals are output from the unit. For details, see the following:

- “Configuring HDMI audio output” (p.36)

- **The HDMI control function is disabled.**

When connecting a TV that supports ARC (Audio Return Channel) to the unit using an HDMI cable only, enable the HDMI control function. To output audio signals from the unit with the HDMI control function disabled, connect the TV's audio output jack to the unit's TV input jack (optical digital) via the optical digital audio cable.

For details, see the following:

- “Configuring the HDMI control function” (p.35)
- “Connecting a TV that does not support Audio Return Channel (ARC)” (p.17)

- **Sound from an HDMI control-enabled TV is set for output from the TV's built-in speakers.**

Use the TV's HDMI settings to set audio output to any option other than the TV's built-in speakers.

No sound is coming from the subwoofer

- **The playback source does not contain low-frequency signals.**

Play back a sound source containing low-frequency signals, and confirm that the sound is output from the subwoofer.

- **The volume is too low.**

Turn up the volume of the subwoofer. For details, see the following:
– “Basic procedure for playback” (p.22)

The volume decreases when the unit is turned on

- **The automatic volume adjustment function is activated.**

To prevent excessive loudness, the unit automatically controls its volume within a certain level when the unit is turned on. Turn up the volume as required. For details, see the following:

– “Basic procedure for playback” (p.22)

No surround effect

- **Stereo playback is selected.**

Select surround playback or 3D surround playback. For details, see the following:

– “Playback with 3D surround sound/surround sound” (p.27)

- **The volume is too low.**

Turn up the volume. For details, see the following:

– “Basic procedure for playback” (p.22)

- **The TV or AV device is set to output 2-channel audio (such as PCM) only.**

Change the digital audio output setting on the TV or AV device to multi-channel linear PCM or bitstream.

- **Sound is also heard from the TV built-in speakers.**

Set the TV volume to minimum.

- **The listening position is too close to the unit.**

The listening position should be at some distance from the unit.

Noise is heard

- **The unit is too close to another digital or high-frequency device.**

Move those devices away from the unit.

When any problem occurs (Bluetooth®)

The unit cannot be connected to a Bluetooth® device

- **Bluetooth is not selected as the input source.**
Select Bluetooth as the input source. For details, see the following:
 - “Listening to audio from a Bluetooth® device” (p.29)
- **The unit is too far away from the Bluetooth device.**
Move the Bluetooth device closer to the unit.
- **A device emitting electromagnetic waves (such as a microwave oven, a wireless device, etc.) may be located nearby.**
Do not use the unit near devices that emit electromagnetic waves.
- **The Bluetooth device you are using may not support the A2DP profile.**
Use a Bluetooth device that supports the A2DP profile.
- **The connection profile registered in the Bluetooth device may not be functioning correctly.**
Delete the connection profile in the Bluetooth device, and then connect the Bluetooth device to the unit.
- **The passkey for devices such as a Bluetooth adapter is not “0000”.**
Use a Bluetooth device with a passkey of “0000”.
- **The unit is already connected to another Bluetooth device.**
Terminate the current Bluetooth connection, and then connect to the new device.

No sound can be heard or the sound cuts off intermittently from a Bluetooth® device

- **The volume on the Bluetooth device may be too low.**
Raise the volume on the Bluetooth device.
- **Bluetooth is not selected as the input source.**
Select Bluetooth as the input source. For details, see the following:
 - “Listening to audio from a Bluetooth® device” (p.29)
- **Playback on the Bluetooth device has not been performed.**
Perform playback on the Bluetooth device.
- **The sound output on the Bluetooth device may not be set to the unit.**
Select the unit as the output destination on the Bluetooth device.
- **The connection to the Bluetooth device was terminated.**
Connect with the Bluetooth device one more time.
- **The unit may be too far away from the Bluetooth device.**
Move the Bluetooth device near the unit.
- **A device emitting electromagnetic waves (such as a microwave oven, a wireless device, etc.) may be located nearby.**
Do not use the unit near devices that emit electromagnetic waves.

When any problem occurs (Network trouble)

The network feature does not function

- **The network parameters (IP address) have not been obtained properly.**
Enable the DHCP server function on the wireless router.
- **The unit does not support IPv6 network.**
Connect IPv4 network.

The unit cannot connect to the Internet via a wireless router (access point)

- **The wireless router (access point) is turned off.**
Turn on the wireless router.
- **The unit and the wireless router (access point) are too far apart.**
Place the unit and the wireless router (access point) closer to each other.
- **There is an obstacle between the unit and the wireless router (access point).**
Move the unit and the wireless router (access point) in a location where there are no obstacles between them.
- **The wireless router (access point) is configured to use a specific wireless channel.**
Change wireless router settings so that a channel is selected automatically. If a specific channel will be specified, specify channel 1 or 11.

Wireless network is not found

- **Microwave ovens or other wireless devices might disturb the wireless communication.**
Turn off these devices or move them farther away from the unit and wireless router.
- **Access to the network is restricted by the firewall settings of the wireless router (access point).**
Check the firewall setting of the wireless router (access point).

The streaming service cannot be played

- **The selected streaming service is currently not available.**
Play the streaming service later.
- **Access to the network is restricted by the firewall settings of your network devices (such as the router).**
Check the firewall settings of your network devices. The streaming service can be played only when it passes through the port designated by each streaming service. The port number varies depending on the streaming service.

The Sound Bar Controller app does not detect the unit

- **The unit and mobile device are not in the same network.**
Check the network connections and router's settings, and then connect the unit and mobile device to the same network.
- **The mobile device is not connected to the network using the 2.4-GHz band.**
Connect the mobile device to the network using the 2.4-GHz band.

- **The mobile device is not connected to the wireless router over a wireless connection.**

Connect the mobile device to the wireless router over a wireless connection.

- **The unit is connected to a multiple SSID router.**

The router's network splitter may be blocking access to the unit. Connect the unit and mobile device to a network with the same SSID. Try connecting to the primary SSID first.

- **The wireless (Wi-Fi) function is disabled.**

Enable the wireless (Wi-Fi) function. For details, see the following:
– “Enabling/disabling the wireless (Wi-Fi) function” (p.40)

Firmware update via the network is failed

- **It may not be possible depending on the condition of the network.**

Update the firmware via the network again or use a USB memory device.

Specifications

Specifications

The specifications of the unit are as follows.

Amplifier section

Maximum rated output power

- Front L/R 30 W × 2ch
- Subwoofer 60 W

Speaker section

Front L/R

- Type Acoustic suspension type (non-magnetic shielding)
- Driver 5.5 cm (2-1/8") cone × 2
- Frequency response 170 Hz to 22 kHz
- Impedance 6 Ω

Tweeter

- Type Magnetic shielding type
- Driver 2.5 cm (1") dome × 2
- Frequency response 5 kHz to 23 kHz
- Impedance 6 Ω

Subwoofer

- Type Bass reflex type (non magnetic shielding)
- Driver 7.5 cm (3") cone × 2
- Frequency response 62 Hz to 170 Hz
- Impedance 3 Ω (6 Ω × 2)

Decoder

Supported audio signal (HDMI/optical input) PCM (up to 5.1ch)
Dolby Digital (up to 5.1ch)
DTS Digital Surround (up to 5.1ch)

Input jacks

HDMI 1 (HDMI IN)

Digital (optical) 1 (TV)

Output jacks

HDMI 1 (HDMI OUT (ARC))

Analog (RCA/monaural) 1 (SUBWOOFER OUT)

Other jacks

USB 1 (UPDATE ONLY)

LAN 1 (NETWORK)

Bluetooth

Function	Sink function (source device to this unit)
Bluetooth version	Ver 4.2
Supported profiles	A2DP
Supported codecs	Sink function: SBC, AAC
Bluetooth class	Bluetooth Class 2
Range (line-of-sight)	Approx. 10 m (33 ft)
Supported content protection method	SCMS-T (sink function)
[U.K. and Europe models]	
• Radio frequency	2402 MHz to 2480 MHz
• Maximum output power (EIRP)	9.5 dBm (8.9 mW)

Network

Ethernet standard	100BASE-TX/10BASE-T
Supported codecs	WAV (PCM format only) /FLAC: up to 192 kHz ALAC: up to 96 kHz MP3/WMA/MPEG-4 AAC: up to 48 kHz

Wi-Fi function

• Wireless LAN standards	IEEE802.11b/g/n
• Radio frequency band	2.4 GHz
• Available security method	WEP, WPA2-PSK (AES), Mixed Mode
[U.K. and Europe models]	
• Radio frequency	
2.4 GHz band	2402 MHz to 2482 MHz (20 MHz)
• Maximum output power (EIRP)	
2.4 GHz band	18.8 dBm (75.9 mW)

General

Power supply	
• [U.S.A. and Canada models]	AC 100 to 120 V, 50/60 Hz
• [Australia model]	AC 100 to 240 V, 50/60 Hz
• [U.K., Europe and Russia models]	AC 100 to 240 V, 50/60 Hz
• [General model]	AC 100 to 240 V, 50/60 Hz
• [Taiwan and Mexico models]	AC 100 to 120 V, 50/60 Hz
• [China model]	AC 100 to 240 V, 50/60 Hz
• [Korea model]	AC 100 to 240 V, 50/60 Hz
Power consumption	30 W (Rated) 4.3 W (Voice Control Ready)

Standby power consumption

- [U.S.A., Canada, Taiwan and Mexico models]
 - HDMI control off, network standby off 0.2 W
 - HDMI control off, network standby on (Wired/Wi-Fi/Bluetooth) 1.7/1.9/1.7 W
 - HDMI control on, network standby off 0.6 W
 - HDMI control on, network standby on 2.2 W
- [U.K. and Europe models and other models]
 - HDMI control off, network standby off 0.2 W
 - HDMI control off, network standby on (Wired/Wi-Fi/Bluetooth) 1.7/1.9/1.7 W
 - HDMI control on, network standby off 0.6 W
 - HDMI control on, network standby on 2.2 W

Dimensions (W x H x D)

- Installing the unit in front of a TV, etc. 890 × 53 × 131 mm
(35" × 2-1/8" × 5-1/8")
- Mounting the unit on a wall, with spacers 890 × 131 × 62 mm
(35" × 5-1/8" × 2-1/2")

Weight 3.4 kg (7.5 lbs)

■ NOTE

The contents of this manual apply to the latest specifications as of the publishing date. To obtain the latest manual, access the Yamaha website then download the manual file.

Supported HDMI audio and video formats

The following HDMI audio and video formats can be used by the unit.

Audio signals

Audio signal types	Audio signal formats
2ch Linear PCM	2ch, 32 kHz to 192 kHz, 16/20/24 bit
Multi-ch Linear PCM	6ch, 32 kHz to 192kHz, 16/20/24 bit
Bitstream	Dolby Digital, DTS

Video signals

The unit is compatible with the following video signals.

- Deep Color
- x.v.Color
- 3D video signal
- High Dynamic Range (HDR) video
 - HDR10
 - HLG

The unit is compatible with the following resolutions.

- VGA
- 480i/60 Hz
- 480p/60 Hz
- 576i/50 Hz
- 576p/50 Hz
- 720p/60 Hz, 50 Hz
- 1080i/60 Hz, 50 Hz
- 1080p/60 Hz, 50 Hz, 30 Hz, 25 Hz, 24 Hz
- 4K/60 Hz, 50 Hz, 30 Hz, 25 Hz, 24 Hz

Copyright protection standard

This unit supports HDCP version 2.3.

■ NOTE

- Refer to documentation supplied with the AV device, and set the device appropriately.
- When CPPM copy-protected DVD-Audio is played back, video and audio signals may not be output depending on the type of the DVD player.
- The unit is not compatible with HDCP-incompatible HDMI or DVI devices. Refer to documentation supplied with the HDMI or DVI device for HDCP compatibility.
- To decode audio bitstream signals on the unit, set the input source device appropriately so that the device outputs the bitstream audio signals directly (does not decode the bitstream signals on the device). Refer to documentation supplied with the device for details.
- The resolution of transmitted video signal varies according to specifications of the TV connected to the unit.
- The contents of this manual apply to the latest specifications as of the publishing date. To obtain the latest manual, access the Yamaha website to download the manual file.

Supported digital audio formats

The following digital audio formats can be used by the unit.

Optical

Audio signal types	Audio signal formats
2ch Linear PCM	2ch, 32 kHz to 96 kHz, 16/20/24 bit
Bitstream	Dolby Digital, DTS

HDMI (ARC)

Audio signal types	Audio signal formats
2ch Linear PCM	2ch, 32 kHz to 96 kHz, 16/20/24 bit
Bitstream	Dolby Digital, DTS

■ NOTE

The contents of this manual apply to the latest specifications as of the publishing date. To obtain the latest manual, access the Yamaha website to download the manual file.

Information for qualified contractors or dealers

Mounting the unit on a wall

Mount the unit on a wall using the screw holes on the rear panel.



CAUTION

- Please have a qualified contractor or dealer when mounting the unit on a wall. Some skills and experience are required for safe installation.
- To prevent the unit from falling, attach it to a wall constructed of drywall (plasterboard).
- Make sure you use screws (sold separately) that can support the weight of the installation. Using clamps other than specified screws, such as short screws, nails, and two-sided tape, may cause the unit to fall.
- Fix the cables in place where they will not become loose. If your foot or hand accidentally gets caught on a loose cable, the unit may fall.
- Do not lean on the unit or apply excessive force to the top of the unit. Doing so may cause the unit to fall.
- Check that the unit is securely fixed after the installation. Yamaha will bear no responsibility for any accidents caused by improper installations.

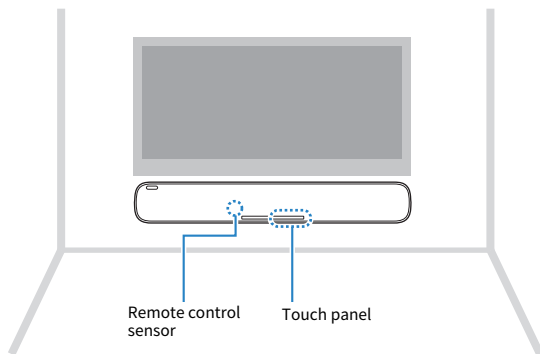

- 1 Attach the mounting template (supplied) on a wall and mark for the screw holes.**

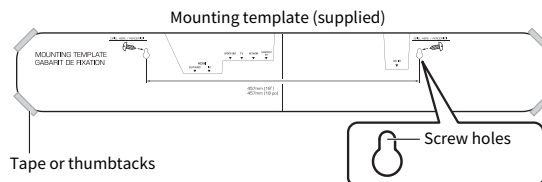

- 2 Remove the mounting template from the wall, and then install screws (sold separately) at the points marked on the wall.**

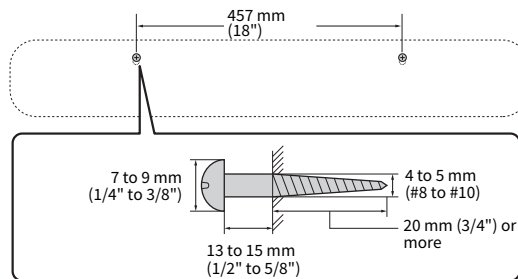

- 3 Peel off the backing paper from the spacers (supplied) and attach the adhesive face to the bottom of the unit.**

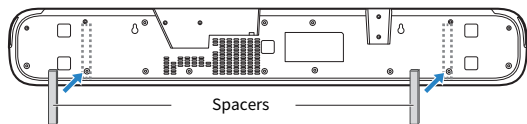

- 4 Hang the unit on the screws.**

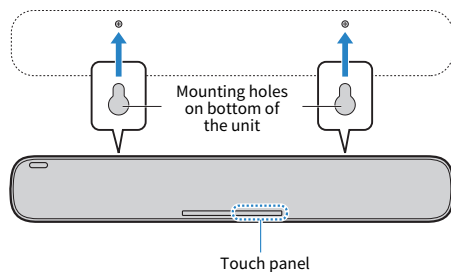

YAMAHA CORPORATION

10-1 Nakazawa-cho, Naka-ku, Hamamatsu, 430-8650 Japan

Yamaha Global Site
<https://www.yamaha.com/>

Yamaha Downloads
<https://download.yamaha.com/>

Manual Development Group
© 2019 Yamaha Corporation

Published 09/2019 NV-B0

AV18-0028